

# TECHNICAL SPECIFICATION

FOR

## **40' X 8' X 8'6" ISO 1AA TYPE STEEL DRY CARGO CONTAINER**

WITH

**ALL SPA-H**

CORRUGATED DOOR  
CORRUGATED ROOF  
GOOSENECK TUNNEL  
2 VENTILATORS  
PLYWOOD FLOOR  
DOORS ON BOTH END

FOR

**GROUP STANDARD**



---

**Note:**

- 1) This file is strictly confidential and privileged. It is intended only for the use of the intended recipient.
- 2) If you are not the intended recipient, any part of this file should not be copied, forwarded or used for any purpose or disclosed to any person without the permission of factory.

## SCOPE

This specification covers the design, construction, materials, testing, inspection and performance requirements for ISO, IAA type steel dry cargo containers manufactured by factory.

The containers specified herein are manufactured under the quality control of FACTORY within the perimeters as such set forth by the Classification Societies.

## CONTENTS

1.	GENERAL-----	3-4
2.	DIMENSIONS AND RATINGS-----	4-5
3.	MATERIAL AND CONSTRUCTION-----	5-10
4.	SURFACE PREPARATION AND PROTECTION-----	10-11
5.	MARKINGS-----	11
6.	TESTING AND INSPECTION-----	11-12
7.	WARRANTY-----	12

## APPENDIX

A.	MATERIAL LIST OF MAIN STEEL PARTS-----	13
B.	TESTING ITEMS, LOADS AND CRITERIA-----	14

---

**Note:**

- 1) This file is strictly confidential and privileged. It is intended only for the use of the intended recipient.
- 2) If you are not the intended recipient, any part of this file should not be copied, forwarded or used for any purpose or disclosed to any person without the permission of factory.

**I. GENERAL****I.1. Operational Environment**

The container is designed and manufactured for the carriage of general cargo by marine, road, and rail. It is designed to maintain its structural and weathertight integrity within a temperature range of -30 °C to 80 °C.

**I.2. Regulations and Standards**

The container will conform to and satisfy the following regulations and standards.

**I.2.1 ISO/TC-104**

All to meet series 1 freight containers set forth.

ISO 830 ----- Freight containers-Terminology.

ISO 668 ----- Series 1 freight containers-Classification, external dimensions and ratings.

ISO 6346 ----- Freight containers-Coding, identification and marking.

ISO 1161 ----- Series 1 freight containers-Corner fittings-specification.

ISO 1496-1 ----- Series 1 freight containers-Specification and testing-  
Part 1 : General cargo containers

**I.2.2 T.I.R. Requirements and Certifications**

The container shall comply with the customs convention of containers, 1972 and all subsequent revisions to date and will be identified with appropriate approval plates and markings.

**I.2.3 Timber Component Treatment and Certification**

All exposed timber components are treated with an Australian government approved insecticide and the container will be such identified with appropriate immunization plate.

**I.2.4 U.I.C. Registration**

The container will be registered and comply with the International Union of Railways (UIC) code 592 OR .

**I.2.5 CSC Requirements**

The container will comply with the rules set forth in the International Convention for Safe Containers and will be so identified with a plate.

**I.2.6 Classification Society**

The container will be certified by Classification Society in design and individually inspected during its production.

**I.3. Handling**

The container will be constructed to be handled under the following conditions without distortion or effect on its structural integrity:

**Note:**

1) This file is strictly confidential and privileged. It is intended only for the use of the intended recipient.

2) If you are not the intended recipient, any part of this file should not be copied, forwarded or used for any purpose or disclosed to any person without the permission of factory.

- A. Lifting full by its top corner fittings by means of spreaders.  
 B. Lifting full by its bottom corner fittings by means of fitting at a sling angle of 30 degrees.

#### **1.4. Transportation**

The container will be constructed to be suitable for transportation in normal operating conditions by modes of:

- A. Marine - on deck by vertical or diagonal lashings or in cell guided  
 B. Rail - on flat or container car secured at its bottom corner fittings  
 C. Road - on flat or chassis secured at its bottom corner fittings

## **2. DIMENSIONS AND RATINGS**

### **2.1 Dimension**

Title		40'DD	
External (mm)	Length	12,192	(0, -10)
	Width	2,438	(0, -5)
	Height	2,591	(0, -5)
Internal (mm)	Length	11,978	(0, -10)
	Width	2,352	(0, -5)
	Height	2,393	(0, -5)
Door opening(mm)	Width	2,340	(0, -5)
	Height	2,280	(0, -5)

### **2.2 Diagonal Difference**

Diagonal tolerance of front and rear frames should be less than 10 MM.  
 Diagonal tolerance of side and roof panels should be less than 19 MM.

### **2.3 Internal Capacity**

67.4 CU.M. (2,380 CU.FT.)

### **2.4 Gooseneck Tunnel**

Length .....	3,141	mm
Width .....	1,029 (+3, 0)	mm
Height .....	120 (0, -3)	mm

### **2.5 Ratings**

Title	KGS	LBS
Max. Gross Weight	32,500	71,650
Tare Weight	3,850	8,490
Max. Payload	28,650	63,160

### **2.6 Corner Protrusions**

- 2.6.1 The faces of the bottom corner fittings protrude from lowerfaces of all transverse members in the base of the container by 17 MM (+0.5, -6 MM)

#### **Note:**

- 1) This file is strictly confidential and privileged. It is intended only for the use of the intended recipient.  
 2) If you are not the intended recipient, any part of this file should not be copied, forwarded or used for any purpose or disclosed to any person without the permission of factory.



- 2.6.2 The upper faces of top corner fittings protrude from upper faces of the highest point of the roof by 6 MM.
- 2.6.3 The outer side faces of corner fittings protrude from outside faces of corner posts by 3 MM.
- 2.6.4 Under 1.8 x max. gross weight no part of the base will protrude more than 6 MM below the bottom corner fittings.

### 3. MATERIAL AND CONSTRUCTION

#### 3.1. General

The container is mainly constructed with steel frames, corrugated panels welded by CO<sub>2</sub> shielded Arc welding. All welds of the exterior including the base frames are continuous with full penetration. Wooden floor is fixed to the cross members by self-tapping screws. All crevices will be sealed with elastic sealing compound.

#### 3.2. Materials

The main constructional materials are shown in Appendix A of the specification.

#### 3.3. Corner Fittings

All corner fittings used will comply with ISO/1161 standard.

#### 3.4. Base Structure

The base structure will be composed of two (2) bottom side rails, a number of crossmembers and one gooseneck tunnel, which are welded together as a sub-assembly.

##### 3.4.1 Bottom Side Rail

Each bottom side rail is built of a steel pressing made in one piece. The bottom flange face outwards so as to be easily repaired and hard to corrode.

Qty. : 2 pcs  
 Shape : Double "Z" section  
 Dimension : 155 x 52 x 30 x 28 x 4.5mm

##### 3.4.2 Crossmember

The crossmembers are composed of a number of small pressed channel section and some large one located beneath each board joint of the plywood, which are placed at certain center distance. There are 3 pcs of t4.0 stiffeners in each joint member.

Shape : "C" section  
 Small one : 122 x 45 x 45 x 4.0 mm Qty. : 25 pcs.  
 Large one : 122 x 75 x 45 x 4.5 mm Qty. : 3 pcs.

#### Note:

- 1) This file is strictly confidential and privileged. It is intended only for the use of the intended recipient.
- 2) If you are not the intended recipient, any part of this file should not be copied, forwarded or used for any purpose or disclosed to any person without the permission of factory.

### 3.6.3 Door Sill

The rear door sill is built of a special channel section steel pressing with internal ribs as stiffeners at the back of each cam keeper. The upper face of the sill has a slope for better drainage and the highest part is on the same level to the upper face of the wooden floor. Two channel section steel recesses are provided adjacent to the bottom fitting to prevent damage due to any twistlock misalignment.

Door sill : 4.5 mm thick    Slope : 10 mm  
 Stiffener ribs : 4.0 mm thick    Qty. : 4 pcs.  
 Channel section : 200 x 75 x 9.0 mm

## 3.7 Side Wall Assembly

The side walls will be continuously welded to each other and to the end rails and corner posts. Welding penetration side panels to rails should be min.75%.

### 3.7.1 Top Side Rails

Each top side rail is used a square steel pipe.                      Rail : 60 x 60 x 3.0 mm

### 3.7.2 Side Walls

Each side wall will be composed of a number of sheets for the intermediate (inner) parts and outer panels at each end of side wall, fully vertically corrugated into trapezium section, butt welded together to form one panel by automatic welding.

Trapezium –    Depth : 36 mm  
                     Outerface : 72 mm  
                     Interface : 70 mm  
                     Slope : 68 mm  
                     Pitch : 278 mm

- a) Inner panel : 1.6 mm thick, Qty. : 9 pcs / each side.  
 b) Outer panel : 2.0 mm thick, Qty. : 2 pcs / each side.

## 3.8 Roof

The roof will be constructed by several die-stamp corrugated steel sheets with a certain upwards camber at the center of each trough and corrugation, these sheets are butt jointed together to form one panel by automatic welding.

Corrugation shape –    Depth : 20 mm  
                                   Outerface : 91 mm  
                                   Interface : 91 mm  
                                   Slope : 13.5 mm  
                                   Pitch : 209 mm

Camber upwards : 5 mm  
 Panel thickness : 2.0 mm  
 Sheet Qty. : 11 pcs

### 3.8.1 Roof Reinforcement Plate

Four reinforcement plates shall be mounted around the four corner fittings.

Dimension : 300 x 250 x 3.0 mm

#### Note:

- 1) This file is strictly confidential and privileged. It is intended only for the use of the intended recipient.
- 2) If you are not the intended recipient, any part of this file should not be copied, forwarded or used for any purpose or disclosed to any person without the permission of factory.

### 3.9 Door

The door consists of two door leaves, each leaf with two locking devices, four hinges, seal gaskets and door holders.

#### 3.9.1 Door Leaf

Each leaf consists of door panel, steel door frame which consists of vertical (inner & outer) and horizontal (upper & lower) members. They are welded together to form the rectangular door leave.

##### 3.9.1.1 Door panel : With 5 corrugations.

Panel thickness :	2.0 mm
Depth :	36 mm
Interface :	70 mm
Slope :	68 mm

##### 3.9.1.2 Door frame : a) Vertical door member : 100 x 50 x 3.2 mm (inner & outer) b) Door horizontal rail : Channel section, 150 x 50 x 3.0 mm.

##### 3.9.1.3 Each door is capable of swinging 270 degrees when fully opened and can be secured in that position by means of nylon ropes attached.

##### 3.9.1.4 The right door is so designed that the right door must be opened before the left in compliance with T.I.R. requirements.

#### 3.9.2 Door gasket

The door gasket is of extruded EPDM with a double lip to ensure water tightness. The upper and side gaskets are of 'J' type configuration. Bottom is of a 'C' type configuration. It is attached with sealant and secured with ABS retainers by stainless steel rivets (stainless rivet and steel shaft). The door gasket middle upper corner is overlap to left door area with wider outer lip.

#### 3.9.3 Hinges and Pins

Four forged hinges, providing with bushed hole, are welded to each door leaf. Each door is installed by hinge pins, washers and bushings.

Washer	- Stainless steel, under the bottom of hinge
Bushing	- Self-lubricating synthetic
Pin	- Stainless steel

#### 3.9.4 Locking Devices

Galvanized locking devices are secured to the door with nuts and bolts and has nylon bushings on the brackets. The locking devices will be hot dip galvanized to 75 micron and will be installed after the container is painted.

#### 3.9.7 Door Holder and Receptacle

A door holder per door, made of mixed nylon rope, is tied to the center-side locking rod and the receptacle (hook type) is welded to each bottom side rail to retain the door at the open position.

#### Note:

- 1) This file is strictly confidential and privileged. It is intended only for the use of the intended recipient.
- 2) If you are not the intended recipient, any part of this file should not be copied, forwarded or used for any purpose or disclosed to any person without the permission of factory.

- 3) Capabilities of pull load of every lashing point are as following:

Lashing rings on the side rails : 1,500 kg / each

Lashing bars on the corner posts : 1,000 kg / each

- 3.12.3 The 3d locking devices of front door must be secured with bolts of M10X45 and nuts by welding between the bolt and nut at the hole of the handles.
- 3.12.4 Two piece of connecting panel which paint with interior top coat is installed on the horizontal door members of the front door by bolts and nuts to fix two leaves.
- 3.12.5 Ventilators – Two (2) ventilators should be small type fabricated from A.B.S. resin by injection molding process. They will be secured to the panel recess near right corner post of both side walls, by means of three (3) Aluminum Huck bolts.

## 4. SURFACE PROTECTION

### 4.1. Surface Preparation

All steel components, prior to forming, will be shot-blasted to a SA 2.5 standard surface by means of an automatic centrifugal shot surface cleaning machine. A weld-able primer compatible to the paint system will be applied immediately to a thickness of 10 micron to preserve the surface integrity during the assembly process. After the container is assembled it is shot-blasted again manually to clean all the welds and any other area that was contaminated during the assembly process. Slags and spatters are removed by means of grinding or needle hammers.

### 4.2 Paint

The zinc content of zinc rich primer shall be no less than 65% measured by weight of solid.

#### *Exterior:*

Apply one coat of zinc rich primer to 25 mic. DFT.

Apply one coat of epoxy primer to 40 mic. DFT.

Apply one coat of Acrylic top coat to 40 mic. DFT.

Total minimum 105 mic. DFT.

#### *Interior: RAL 7035*

Apply one coat of zinc rich primer to 25 mic. DFT.

Apply one coat of epoxy top coat to 50 mic. DFT.

Total minimum 75 mic. DFT.

### 4.3 Undercoating

The whole underside will be coated with 25 mic. of zinc rich primer and 200 mic. of Waxy or Bituminous undercoating.

Total minimum 225 mic. DFT.

## 5. MARKING

### 5.1 Lettering

The container will be marked in accordance with ISO requirements, specifications owner's, and other regulatory authorities.

---

#### **Note:**

1) This file is strictly confidential and privileged. It is intended only for the use of the intended recipient.

2) If you are not the intended recipient, any part of this file should not be copied, forwarded or used for any purpose or disclosed to any person without the permission of factory.

## **5.2. Materials**

The decals are of a cast vinyl self adhesive type and are warranted for seven (7) years against normal wear and tear. All data plates will be stainless steel and secured with stainless steel blind rivets which are sealed at the backside.

## **5.3 Plating and Stamping**

- 5.3.1 Stamped the manufacturer's serial number in 10mm(13/32") high digits on the top face of the right hand lower rear corner fitting and the owner's code & number in same high digits on the left hand rear corner fitting.
- 5.3.2 Chemically etched stainless steel plates (Consolidated data plate i.e. TIR, CSC, TCT) will be permanently riveted with stainless steel blind rivets and sealant will be applied around these plates.

## **6. TESTING AND INSPECTION**

### **6.1. Materials and Parts Inspection**

All materials and parts are inspected by the manufacturer's Quality Control department to ensure they are up to the specification called for in the design.

### **6.2. Production Line Quality Control**

All containers are manufactured under effective quality control procedures to meet the specified standards. All dimensions are checked and smooth operation of the doors are ensured after each container's completion. A light and watertight test is conducted on all containers.

One in every 200 of containers shall be tested for following items:

- 1) Stacking test.
- 2) Lifting from top corner fitting test.
- 3) Lifting from bottom corner fitting test.
- 4) Floor test.

Quality control personnel independent of the production dept. will be inspecting on all phases of the production as well as ad hoc inspections by the classification society's surveyor and buyer's representatives to assure the quality of the container.

## **7. WARRANTY**

### **7.1. Guarantee**

The guarantee period will commence the day after the certification is issued by the classification society.

### **7.2. Paint Guarantee**

The application of paint will be warranted against corrosion and paint failure for a period of five (5) years. The Warranty is for all faults affecting more than 10% of the painted surfaces and will assure partial or total re-painting of the containers. Normal wear/tear, or corrosion caused by acid, alkali or results of damages by abrasion, impact or accident are excluded.

---

#### **Note:**

- 1) This file is strictly confidential and privileged. It is intended only for the use of the intended recipient.
- 2) If you are not the intended recipient, any part of this file should not be copied, forwarded or used for any purpose or disclosed to any person without the permission of factory.

## APPENDIX B

## PROTOTYPE TESTING

The prototype container to be manufactured in accordance with this specification will be tested by manufacturer under the supervision of classification society.

Note: R: Max Gross Weight P: Max Payload T: Tare Weight

	<u>Test items &amp; loads</u>	<u>Test methods</u>
1)	Stacking Internal load : 1.8R-T Test load: 97,200 kg/post	Hydraulic cylinder load will be applied to each corner post through top corner fittings. Offset: 25.4 mm lateral 38.0 mm longitudinal
2)	Lifting (from top corner fittings) Internal load : 2R-T	Lifting vertically. Time duration : 5 minutes
3)	Lifting (from bottom corner fittings) Internal load : 2R-T	Lifting 30 degree to the horizontal. Time duration : 5 minutes
4)	Restraint (longitudinal) Internal load : R-T Test load : 2R	Hydraulic cylinder load will be applied to the bottom side rails.
5)	Floor strength Test load : 7,260 kgs	Use of a special truck. Total contact area: 284 sq. cm Wheel width : 180 mm Wheel centre : 760 mm
6)	End Wall strength Test load : 0.4(R-T)=0.4P	Compressed air bag will be used.
7)	Wall strength (side) Test load : 0.6(R-T)=0.6P	Compressed air bag will be used on one side only.
8)	Roof strength (weakest part) Test load : 300 kgs	Applied area will be 600x300mm longitudinal and transverse.
9)	Rigidity (transverse) Test load : 15,240 kgs	Hydraulic cylinder load will be applied to the header rail through top corner fittings.
10)	Rigidity (longitudinal) Test load : 7,620 kgs	Hydraulic cylinder load will be applied to the top side rail through top corner fitting on one side only. Two times for pulling and pushing.
11)	Weatherproofness	Inside dia. of nozzle : 12.5mm Distance : 1.5 m Speed : 100 mm/sec. Pressure : 1 kg/sq. cm

**Note:**

- 1) This file is strictly confidential and privileged. It is intended only for the use of the intended recipient.
- 2) If you are not the intended recipient, any part of this file should not be copied, forwarded or used for any purpose or disclosed to any person without the permission of factory.

Note: Corrosion is defined as rusting which exceeds RE3 (European scale of degree of rusting) on at least ten (10) percent of the total container surface coated with the concerned coating system.

### **7.3. Other Guarantee**

This container will be guaranteed against any defects or omissions in constructions, workmanship and materials for a period of two (1) years. In the event of defects, FACTORY will replace, correct or install to make the container satisfactory to this specification and its intended service at FACTORY's expense. Any damages caused by mis-handling, mis-securing, mis-loading, impact and any natures of accidents are excluded.

---

**Note:**

- 1) This file is strictly confidential and privileged. It is intended only for the use of the intended recipient.
- 2) If you are not the intended recipient, any part of this file should not be copied, forwarded or used for any purpose or disclosed to any person without the permission of factory.

## APPENDIX A

Material list for main steel parts:

YP = YIELD POINT (KG/MM2)

E = ELONGATION %

TS = TENSILE STRENGTH (KG/MM2)

REAR CORNER POST-OUTER	)	JIS: SPA-H OR EQUIVALENT
DOOR PANEL	)	YP=35 TS=49 E=22
DOOR HEADER	)	
DOOR RAIL	)	
DOOR EDGE MEMBER	)	
DOOR SILL	)	
SIDE PANEL	)	
TOP SIDE RAIL	)	
BOTTOM SIDE RAIL	)	
ROOF PANEL	)	
CROSSMEMBER	)	
REINFORCEMENT PLATE	)	
FLOOR CENTRAL RAIL	)	
DOOR SEAL RETAINER	)	ABS
HINGE PIN	)	STAINLESS STEEL
CONE DAMAGE PROTECTOR	)	JIS: S841 HOT ROLLED SHAPED STEEL YP=25 TS=41 E=21
REAR CORNER POST-INNER	)	JIS: SM50YA HOT-ROLLED HI-TENSILE SHAPED STEEL YP=37 TS=50 E=15 OR S850 HOT-ROLLED HI-TENSILE SHAPED STEEL YP=29 TS=50 E=19
LOCKING BAR	)	JIS: STK41 YP=23 TS=41 E=23
CORNER CASTING	)	JIS: SCW49 MOD. WELDABLE CASTING YP=28 TS=49 E=20
DOOR HINGE	)	JIS: S25C FORGING STEEL YP=28 TS=46 E=20
DOOR LOCKING CAM AND KEEPER	)	JIS: S20C FORGING STEEL YP=25 TS=42 E=19

**Note:**

- 1) This file is strictly confidential and privileged. It is intended only for the use of the intended recipient.
- 2) If you are not the intended recipient, any part of this file should not be copied, forwarded or used for any purpose or disclosed to any person without the permission of factory.



## APPENDIX B

## PROTOTYPE TESTING

The prototype container to be manufactured in accordance with this specification will be tested by manufacturer under the supervision of classification society.

Note: R: Max Gross Weight P: Max Payload T: Tare Weight

	<u>Test items &amp; loads</u>	<u>Test methods</u>
1)	Stacking Internal load : 1.8R-T Test load: 97,200 kg/post	Hydraulic cylinder load will be applied to each corner post through top corner fittings. Offset: 25.4 mm lateral 38.0 mm longitudinal
2)	Lifting (from top corner fittings) Internal load : 2R-T	Lifting vertically. Time duration : 5 minutes
3)	Lifting (from bottom corner fittings) Internal load : 2R-T	Lifting 30 degree to the horizontal. Time duration : 5 minutes
4)	Restraint (longitudinal) Internal load : R-T Test load : 2R	Hydraulic cylinder load will be applied to the bottom side rails.
5)	Floor strength Test load : 7,260 kgs	Use of a special truck. Total contact area: 284 sq. cm Wheel width : 180 mm Wheel centre : 760 mm
6)	End Wall strength Test load : $0.4(R-T)=0.4P$	Compressed air bag will be used.
7)	Wall strength (side) Test load : $0.6(R-T)=0.6P$	Compressed air bag will be used on one side only.
8)	Roof strength (weakest part) Test load : 300 kgs	Applied area will be 600x300mm longitudinal and transverse.
9)	Rigidity (transverse) Test load : 15,240 kgs	Hydraulic cylinder load will be applied to the header rail through top corner fittings.
10)	Rigidity (longitudinal) Test load : 7,620 kgs	Hydraulic cylinder load will be applied to the top side rail through top corner fitting on one side only. Two times for pulling and pushing.
11)	Weatherproofness	Inside dia. of nozzle : 12.5mm Distance : 1.5 m Speed : 100 mm/sec. Pressure : 1 kg/sq. cm

## Note:

- 1) This file is strictly confidential and privileged. It is intended only for the use of the intended recipient.
- 2) If you are not the intended recipient, any part of this file should not be copied, forwarded or used for any purpose or disclosed to any person without the permission of factory.



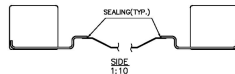
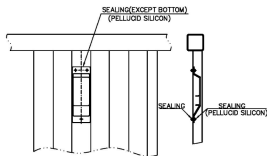
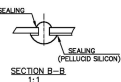
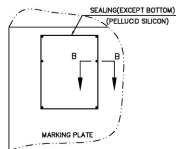
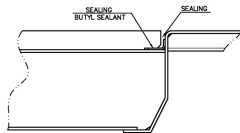
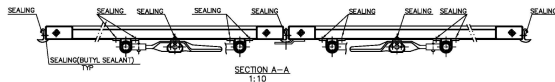
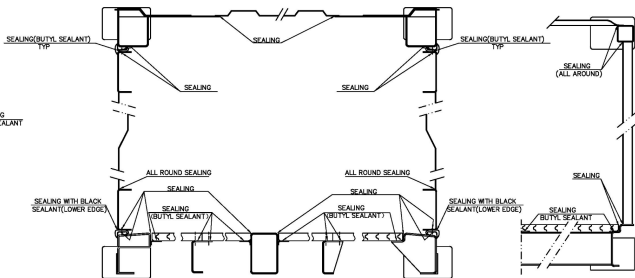
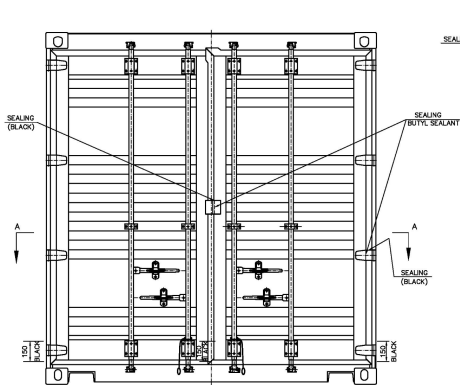

NOTE: NOT SPECIFIED ARE CHLOROPRENE SEALANT.

**FILCO** INDUSTRIAL

TITLE: 40' DD APPLICATION OF SEALANT

OWNED BY:	SCALE: 1:20	SIZE: A3
DESIGNED BY:	WEIGHT: KG.	QTY.:
CHECKED BY:	DWG No.: 1001-DD	
APPROVED BY:		
SHEET 1 OF 1 SHEETS	ISSUE: 1.3A-00	

THIS DRAWING AND ALL COPIES THEREOF ARE CONFIDENTIAL AND THE PROPERTY BELONGS TO FACTORY. ANY PART OF THIS DRAWING SHALL NOT BE COPIED, REPRODUCED, DISCLOSED OR DISTRIBUTED TO A PARTY WITHOUT PRIOR WRITTEN APPROVAL FROM FACTORY.



**3.10 Floor**

## 3.10.1 The Floor Boards

The floor consists of plywood. The plywood used will be certified to meet the requirements of Australian Commonwealth Dept. of Health (Plant Quarantine Treatment Schedule) for Timber Components ( T.C.T. ). The floor dimension should according to the IICL dimension standard. The plywood thickness is 28 mm.

## 3.10.2 Arrangement and Fixing

The plywood boards are longitudinally laid on the crossmember with a pre-blasted painted and free floating flat steel at the center. The plywood boards are tightly secured to each crossmember with countersunk self-tapping electro-zinc plated steel screws. These heads of the floor screws are countersunk below the level of the upper surface of the floor by 2.0 mm to 2.5 mm.

Screws : M8 x 45 x ø16(Head) mm

Screws' Qty. : 5 pcs / end row and joint, 3 pcs / outrigger, 4 pcs / other.

## 3.10.3 The plywood used will be a minimum 19 plies and will be:

- A. Hardwood of a specific gravity range of 0.7-0.85 at a moisture content of 12%. E.G. Keruing, Apitong, Birch,ect.
- B. Moisture content will be 13-15% when fitted to the container.

**3.11 Sealing**

1. Each perimeter of the floor;
2. All the overlapped joints of inside;
3. All the holes for bolts and nuts;
4. Three sides of CSC plate and ventilators;
5. Between door gasket and door panel at 150 mm above lower gasket;
6. Details refer to the application of sealant drawing SGMF-1001-DD.

Note: The application of interior sealant will be put on after water testing.

Sealant Materials : a. Chloroprene or waterborne sealant (Cargo contact area)  
b. Butyl (Hidden parts)

**3.12 Special Features**

## 3.12.1 Shoring Slots: 60x40 MM slots are provided for on each of the rear corner posts so that a 2" thick batten can be secured to give protection against shifting cargo.

## 3.12.2 Lashing Rings and Lashing Bars

- 1) Lashing rings are welded to each bottom and top side rail at corresponding recessed area of side wall.

Lashing ring Qty. / each bottom or top side rail : 10 pcs , total : 40 pcs.

- 2) Lashing bars are welded on each corner post slot.

Lashing bars Qty. / each front & rear corner post : 2 pcs, total : 8 pcs.

**Note:**

- 1) This file is strictly confidential and privileged. It is intended only for the use of the intended recipient.
- 2) If you are not the intended recipient, any part of this file should not be copied, forwarded or used for any purpose or disclosed to any person without the permission of factory.